



Peelers Vegetable Peeler, 8kg with abrasive plate, removable chamber & filter

ITEM # _____

MODEL # _____

NAME # _____

SIS # _____

AIA # _____



603506 (DT8EFB)

8 kg vegetable peeler, abrasive plate, abrasive cylinder and incorporated filter basket

Short Form Specification

Item No. _____

Can be placed on a worktop. 8 kg, removable stainless steel peeling chamber contains the abrasive plate which also serves as a container for carrying the vegetables. Vegetables can be loaded directly into the peeling chamber, away from the machine. Easily assembled onto the base, with the drive shaft fitting into the centre of the plate. The transparent cover closes the cylinder during the peeling operations. Timer pre-set to 3 minutes. Peeling speed: 305 rpm. Removable water inlet, on the cover, designed to serve as a spray for cleaning the machine. The electronic controls and the motor of the peeler have IP55 protection. Optional drying basket.

Supplied with abrasive plate, abrasive cylinder and integrated/removable filter basket.

Main Features

- Removable stainless steel peeling chamber to contain the abrasive plate which also serves as a container to carry the vegetables.
- Supplied with:
 - abrasive plate and abrasive cylinder as standard
- Removable water inlet, clipped to the cover, designed to serve as a spray to clean the machine.
- Red OFF, green ON buttons.
- Peeling time on timer preset to 3 minutes
- Easily fits onto the base, with the drive shaft fitting into the center of the plate.
- Integrated built-in filter device, removable for cleaning.
- Dishwasher safe removable parts.
- Unit can be placed on a work top.
- Suitable for 80-150 meals per service.

Construction

- 1 speed: 305 rpm.
- IP55 waterproof control buttons.
- Transparent BPA free cover.

Included Accessories

- 1 of Abrasive plate for 5/8 kg PNC 653316 vegetable peeler
- 1 of Filter basket for 8 kg PNC 653514 vegetable peeler and 5/8 kg seashell cleaners

Optional Accessories

- Abrasive plate for 5/8 kg PNC 653316 vegetable peeler
- Drying basket for 8 kg PNC 653495 vegetable peeler (only T8E)
- Stainless steel table for 5 PNC 653496 and 8 kg vegetable peelers
- Filter basket for 8 kg PNC 653514 vegetable peeler and 5/8 kg seashell cleaners

APPROVAL: _____



Peelers Vegetable Peeler, 8kg with abrasive plate, removable chamber & filter

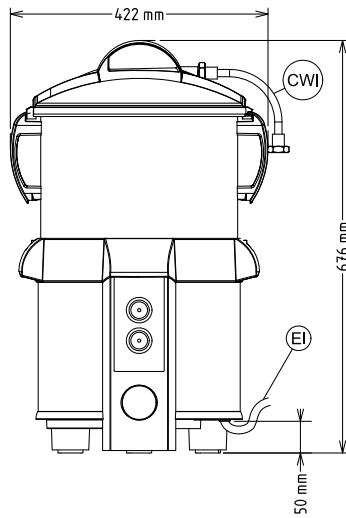

Front

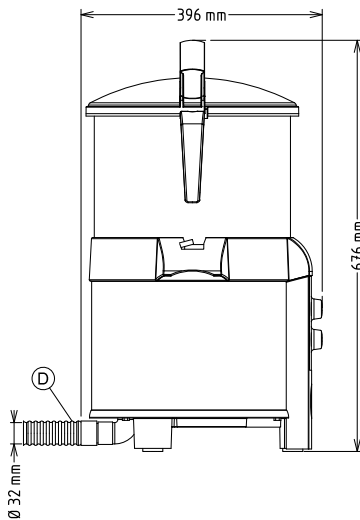

Side

- CWI** = Cold Water inlet 1
(cleaning)
D = Drain
EI = Electrical inlet
(power)

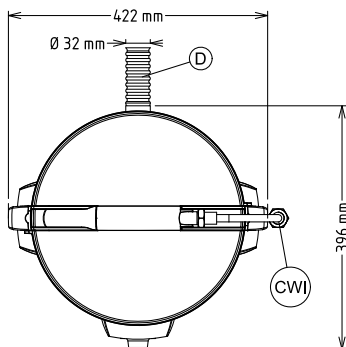

Top

Electric

Supply voltage:

603506 (DT8EFB)

220-240 V/1N ph/50/60 Hz

Electrical power max.:

0.37 kW

Total Watts:

0.37 kW

Capacity:

Performance (up to):

130 kg/hour

Capacity:

8 kg

Key Information:

External dimensions,

Width:

422 mm

External dimensions,

Depth:

396 mm

External dimensions,

Height:

676 mm

Shipping weight:

26 kg



Peelers
Vegetable Peeler, 8kg with abrasive plate, removable chamber & filter
The company reserves the right to make modifications to the products
without prior notice. All information correct at time of printing.

2024.06.08